

ALUCOBOND® EasyFix™: Horizontal - Exterior Insulation

Disclaimer Note: 3A COMPOSITES USA, INC. DOES NOT MAKE ANY WARRANTIES, EXPRESS OR IMPLIED INCLUDING MERCHANTABILITY AND FITNESS FOR PURPOSE. THIS INFORMATION IS GIVEN TO THE BEST OF OUR KNOWLEDGE BUT WITHOUT ANY OBLIGATION ON OUR PART. PATENTED PENDING

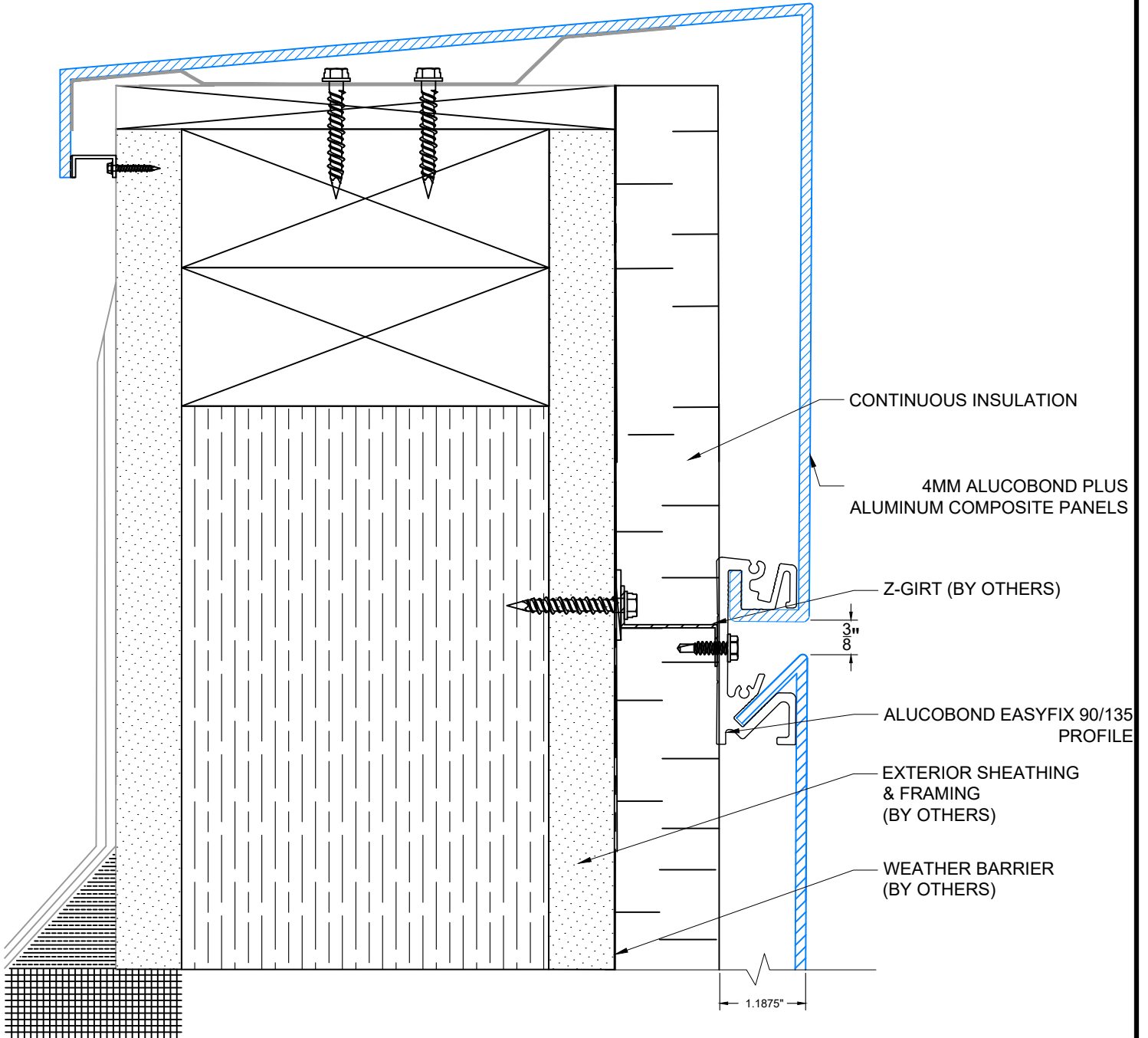

View Point-
Side View

1 PARAPET ALUCOBOND PLUS



ALUCOBOND[®] EasyFix[™]: Horizontal - Exterior Insulation

Disclaimer Note: 3A COMPOSITES USA, INC. DOES NOT MAKE ANY WARRANTIES, EXPRESS OR IMPLIED INCLUDING MERCHANTABILITY AND FITNESS FOR PURPOSE. THIS INFORMATION IS GIVEN TO THE BEST OF OUR KNOWLEDGE BUT WITHOUT ANY OBLIGATION ON OUR PART. PATENTED PENDING

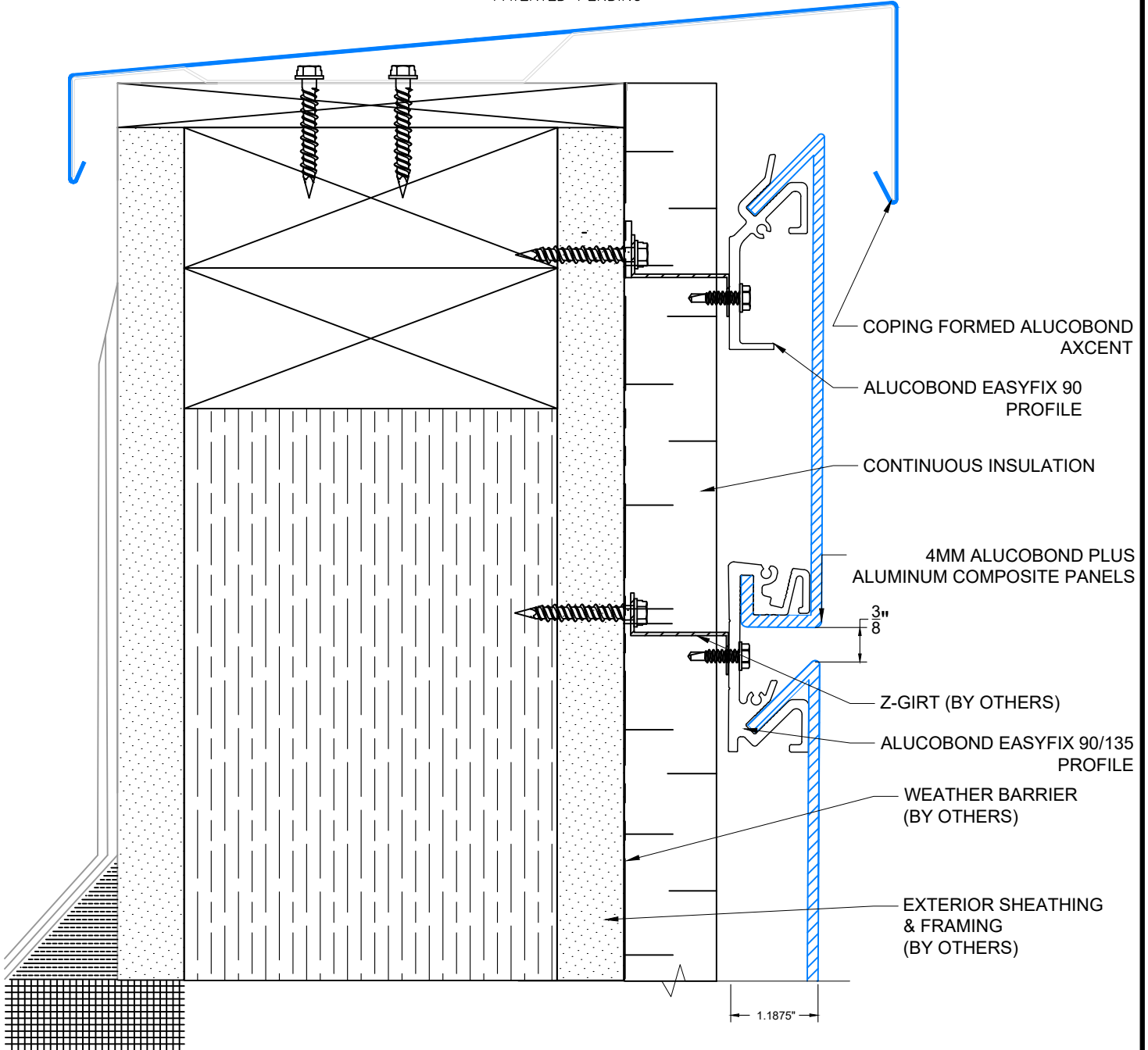

View Point-Side View

1a PARAPET AXCENT



ALUCOBOND® EasyFix™: Horizontal - Exterior Insulation

Disclaimer Note: 3A COMPOSITES USA, INC. DOES NOT MAKE ANY WARRANTIES, EXPRESS OR IMPLIED INCLUDING MERCHANTABILITY AND FITNESS FOR PURPOSE. THIS INFORMATION IS GIVEN TO THE BEST OF OUR KNOWLEDGE BUT WITHOUT ANY OBLIGATION ON OUR PART. PATENTED PENDING

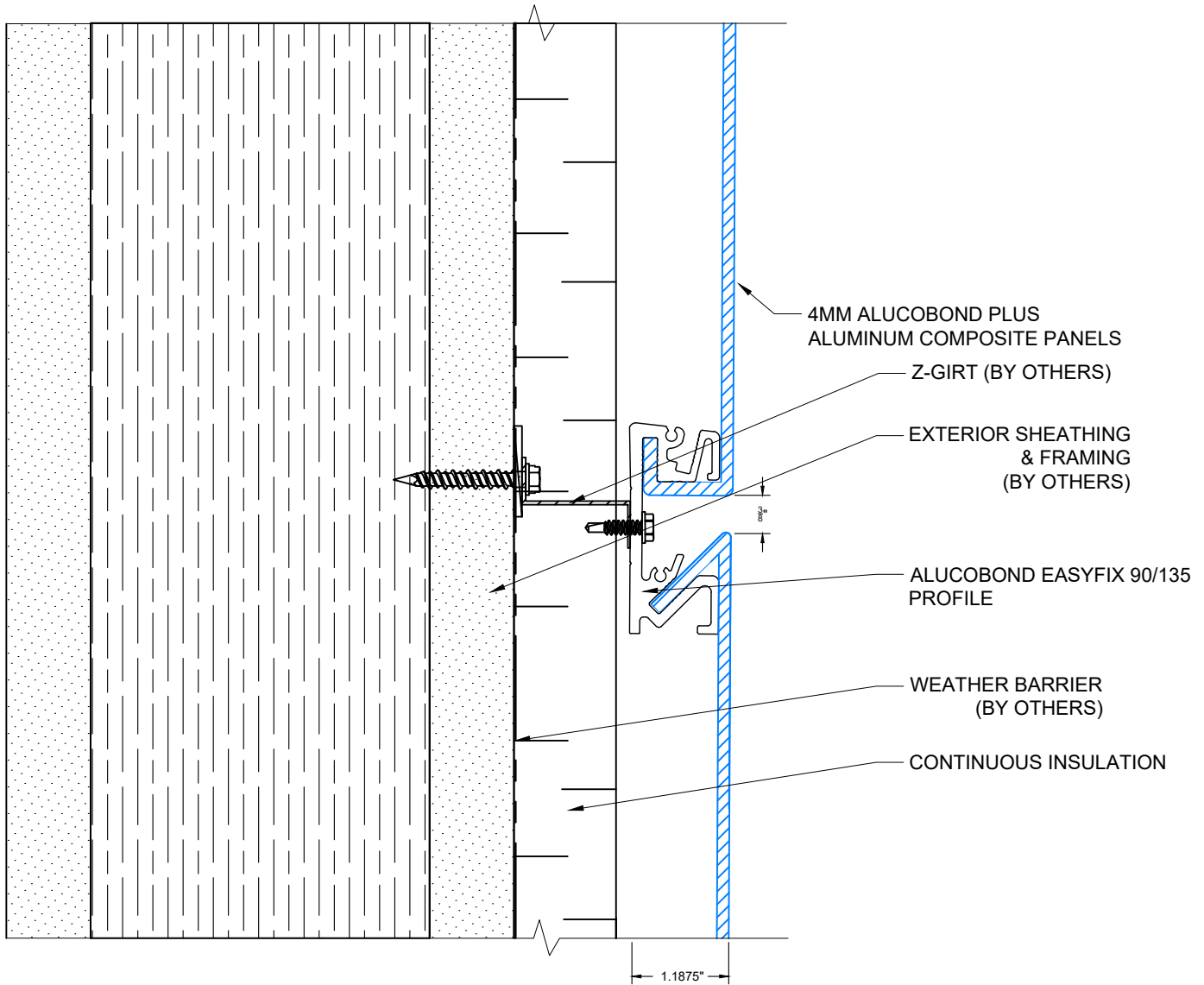

View Point-Side View

2 HORIZONTAL JOINT



ALUCOBOND® EasyFix™: Horizontal - Exterior Insulation

Disclaimer Note: 3A COMPOSITES USA, INC. DOES NOT MAKE ANY WARRANTIES, EXPRESS OR IMPLIED INCLUDING MERCHANTABILITY AND FITNESS FOR PURPOSE. THIS INFORMATION IS GIVEN TO THE BEST OF OUR KNOWLEDGE BUT WITHOUT ANY OBLIGATION ON OUR PART. PATENTED PENDING

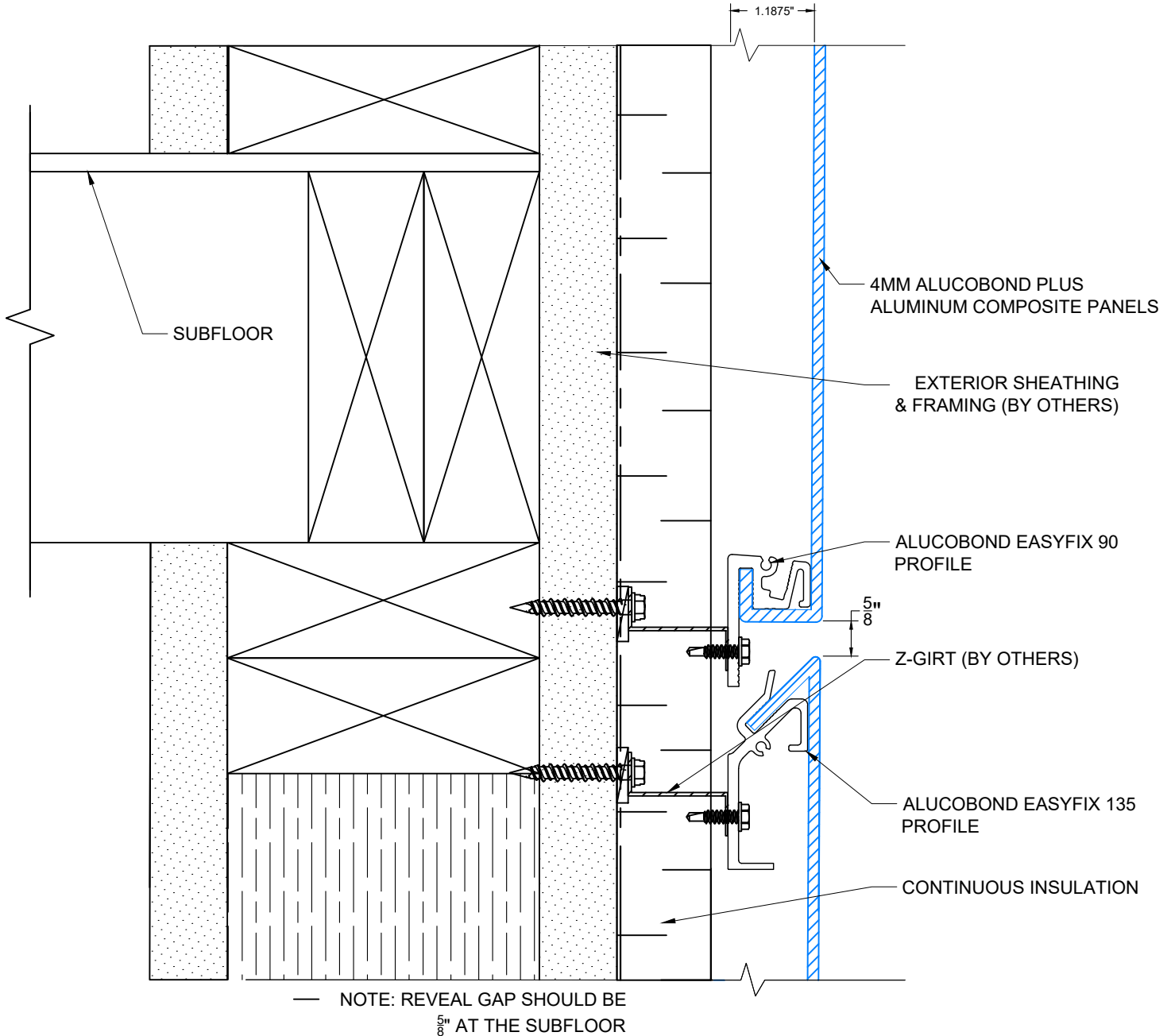

View Point-
Side View

2a FLOOR JOINT

3A COMPOSITES | **ALUCOBOND® PLUS**
GIVING SHAPE TO GREAT IDEAS

ALUCOBOND[®] EasyFix[™]: Horizontal - Exterior Insulation

Disclaimer Note: 3A COMPOSITES USA, INC. DOES NOT MAKE ANY WARRANTIES, EXPRESS OR IMPLIED INCLUDING MERCHANTABILITY AND FITNESS FOR PURPOSE. THIS INFORMATION IS GIVEN TO THE BEST OF OUR KNOWLEDGE BUT WITHOUT ANY OBLIGATION ON OUR PART. PATENTED PENDING

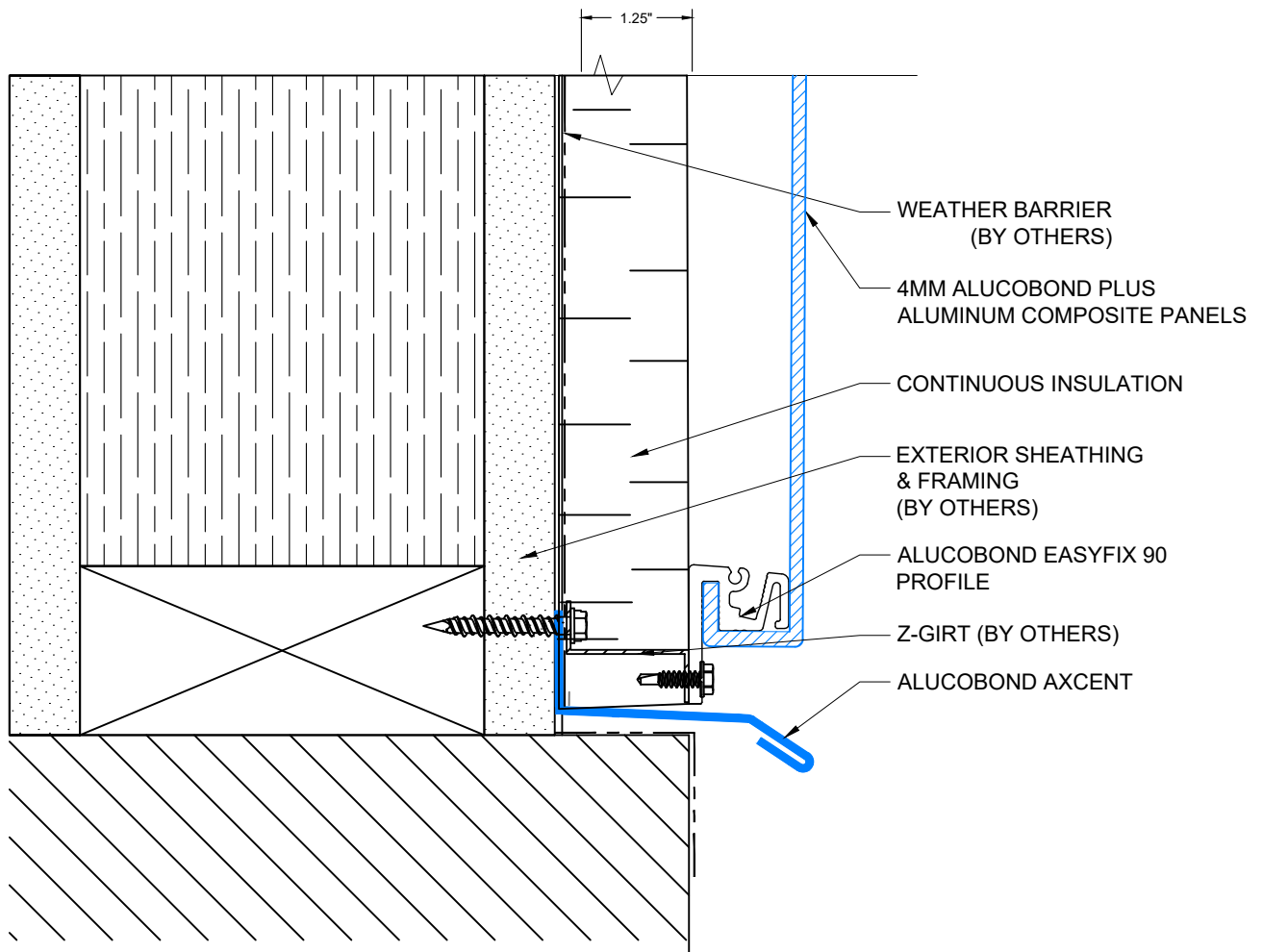

View Point-
Side View

3

BASE CONDITION DETAIL



ALUCOBOND[®] PLUS
GIVING SHAPE TO GREAT IDEAS

ALUCOBOND® EasyFix™: Horizontal - Exterior Insulation

Disclaimer Note: 3A COMPOSITES USA, INC. DOES NOT MAKE ANY WARRANTIES, EXPRESS OR IMPLIED INCLUDING MERCHANTABILITY AND FITNESS FOR PURPOSE. THIS INFORMATION IS GIVEN TO THE BEST OF OUR KNOWLEDGE BUT WITHOUT ANY OBLIGATION ON OUR PART. PATENTED PENDING

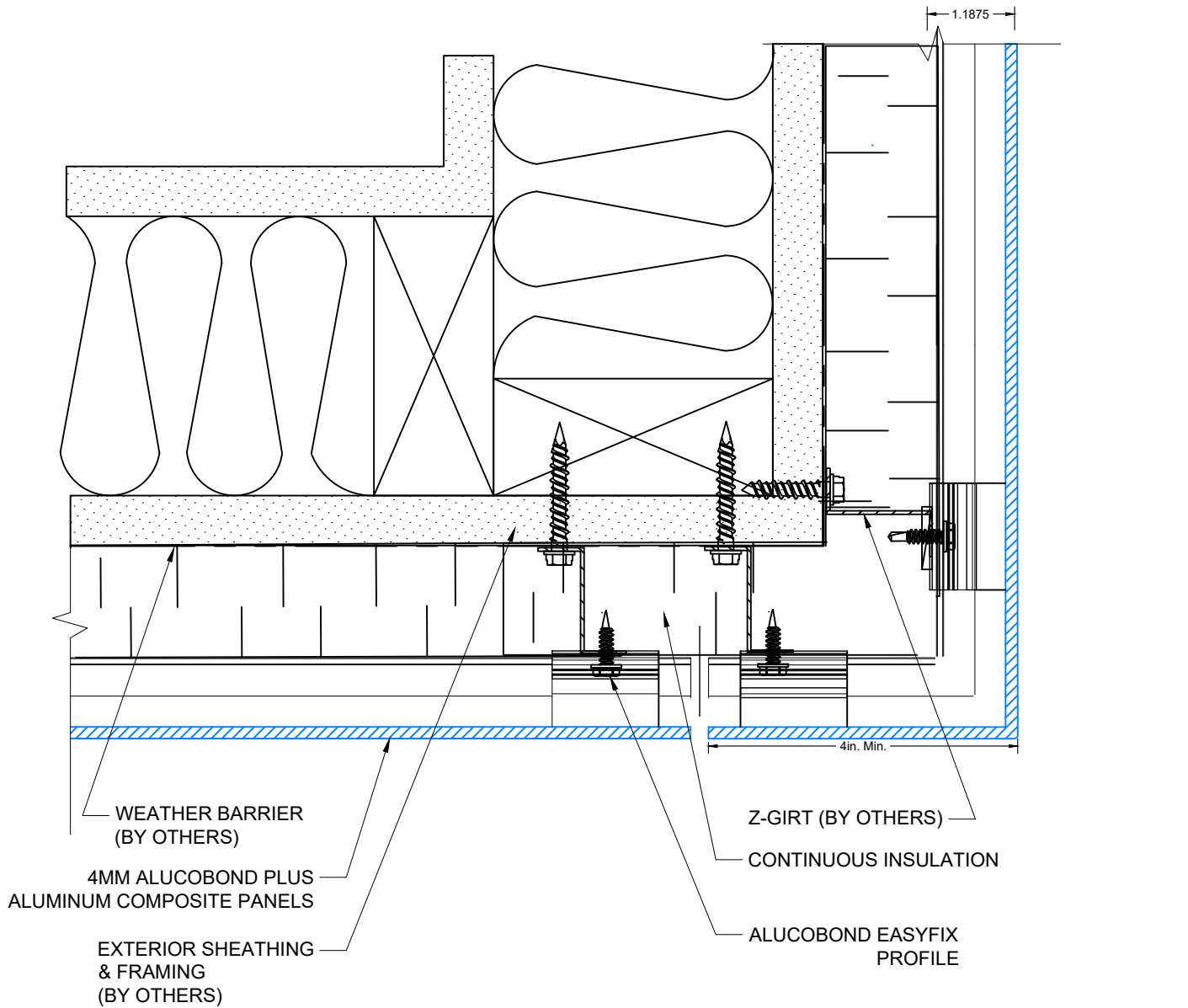

View Point-
Top View

4 OUTSIDE CORNER



ALUCOBOND® EasyFix™: Horizontal - Exterior Insulation

Disclaimer Note: 3A COMPOSITES USA, INC. DOES NOT MAKE ANY WARRANTIES, EXPRESS OR IMPLIED INCLUDING MERCHANTABILITY AND FITNESS FOR PURPOSE. THIS INFORMATION IS GIVEN TO THE BEST OF OUR KNOWLEDGE BUT WITHOUT ANY OBLIGATION ON OUR PART. PATENTED PENDING

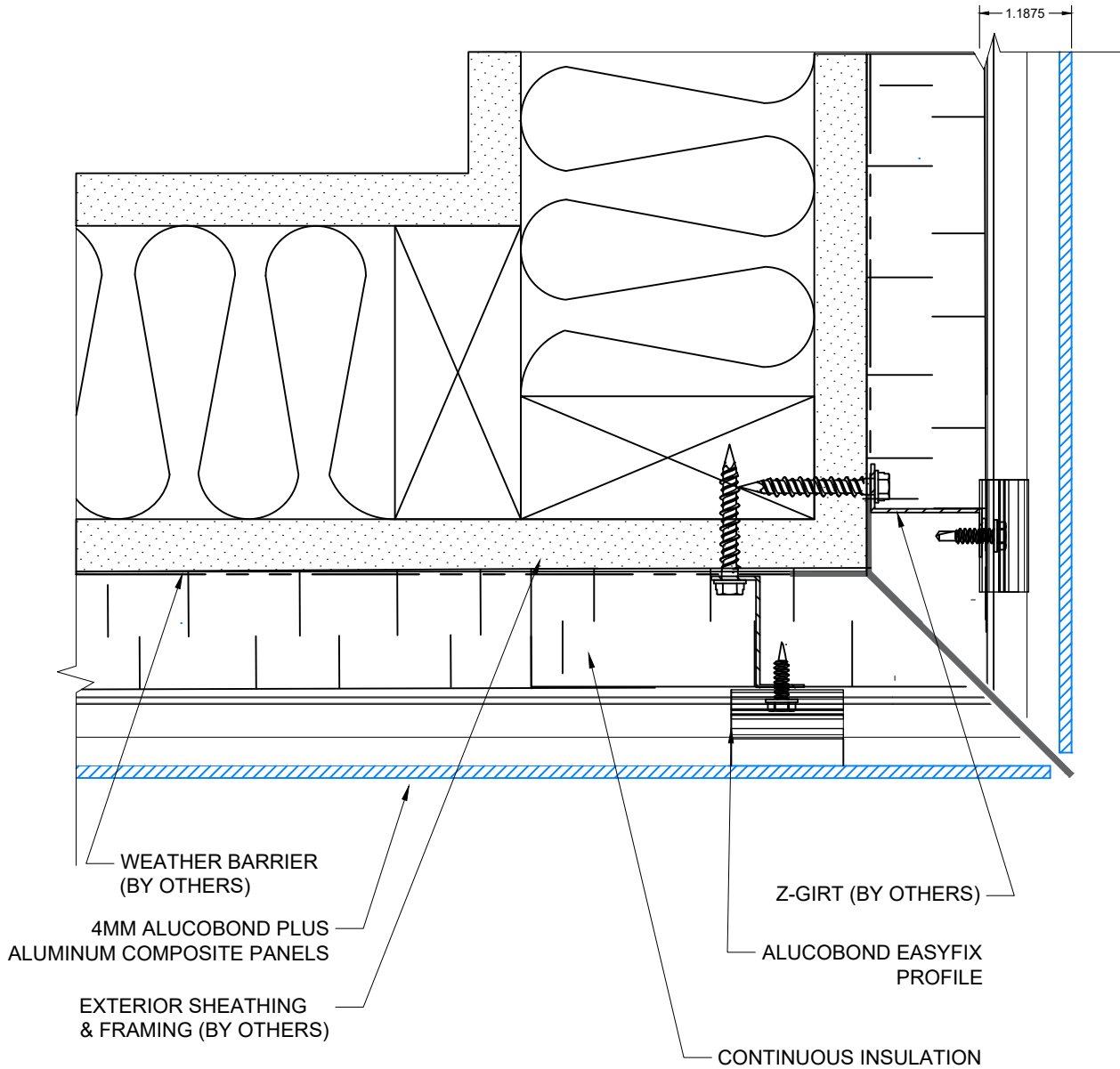

View Point-
Top View

4a OUTSIDE CORNER



ALUCOBOND® EasyFix™: Horizontal - Exterior Insulation

Disclaimer Note: 3A COMPOSITES USA, INC. DOES NOT MAKE ANY WARRANTIES, EXPRESS OR IMPLIED INCLUDING MERCHANTABILITY AND FITNESS FOR PURPOSE. THIS INFORMATION IS GIVEN TO THE BEST OF OUR KNOWLEDGE BUT WITHOUT ANY OBLIGATION ON OUR PART. PATENTED PENDING

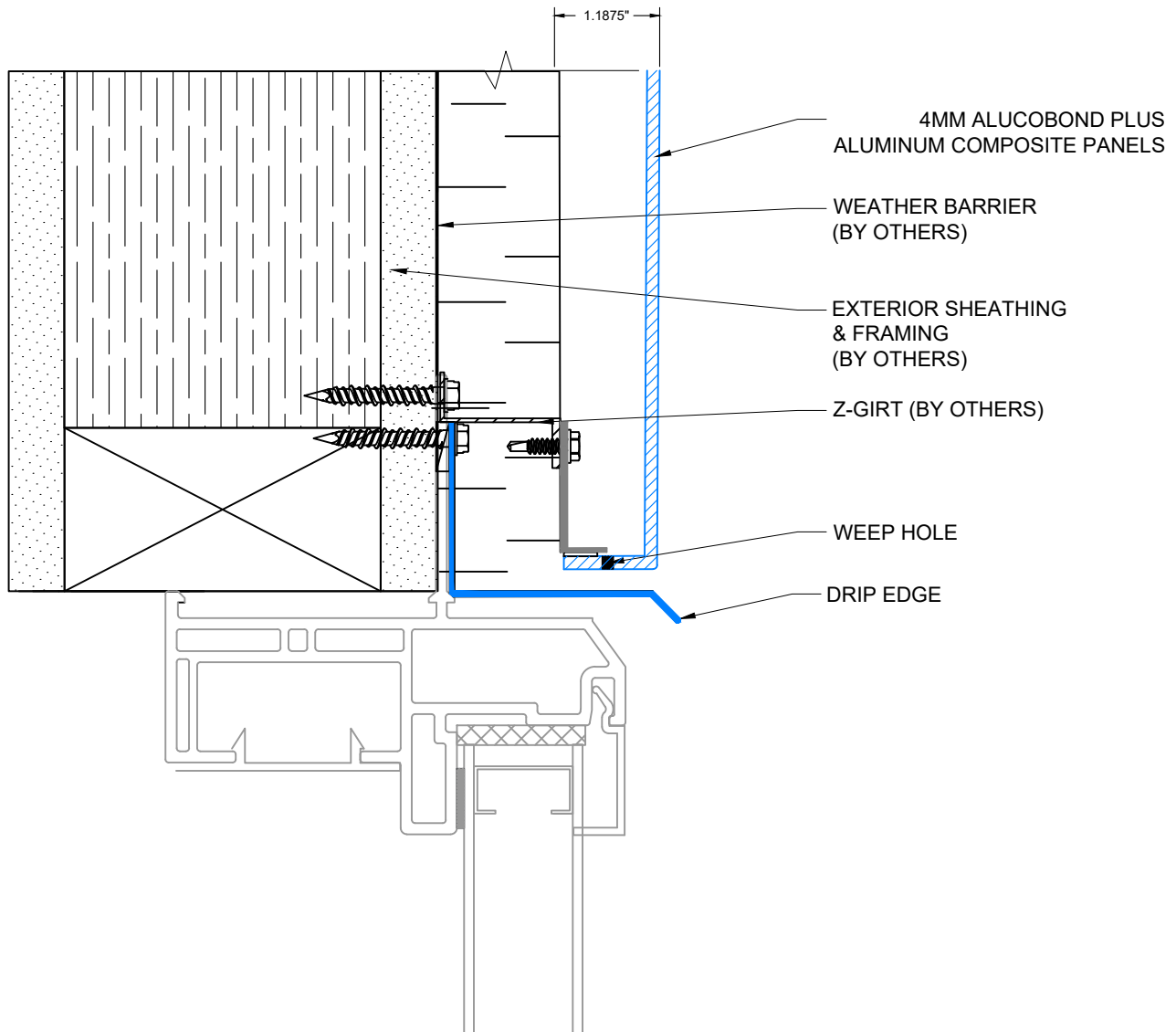

View Point-Side View

5

WINDOW HEAD CONDITION



ALUCOBOND® PLUS
GIVING SHAPE TO GREAT IDEAS

ALUCOBOND® EasyFix™: Horizontal - Exterior Insulation

Disclaimer Note: 3A COMPOSITES USA, INC. DOES NOT MAKE ANY WARRANTIES, EXPRESS OR IMPLIED INCLUDING MERCHANTABILITY AND FITNESS FOR PURPOSE. THIS INFORMATION IS GIVEN TO THE BEST OF OUR KNOWLEDGE BUT WITHOUT ANY OBLIGATION ON OUR PART. PATENTED PENDING

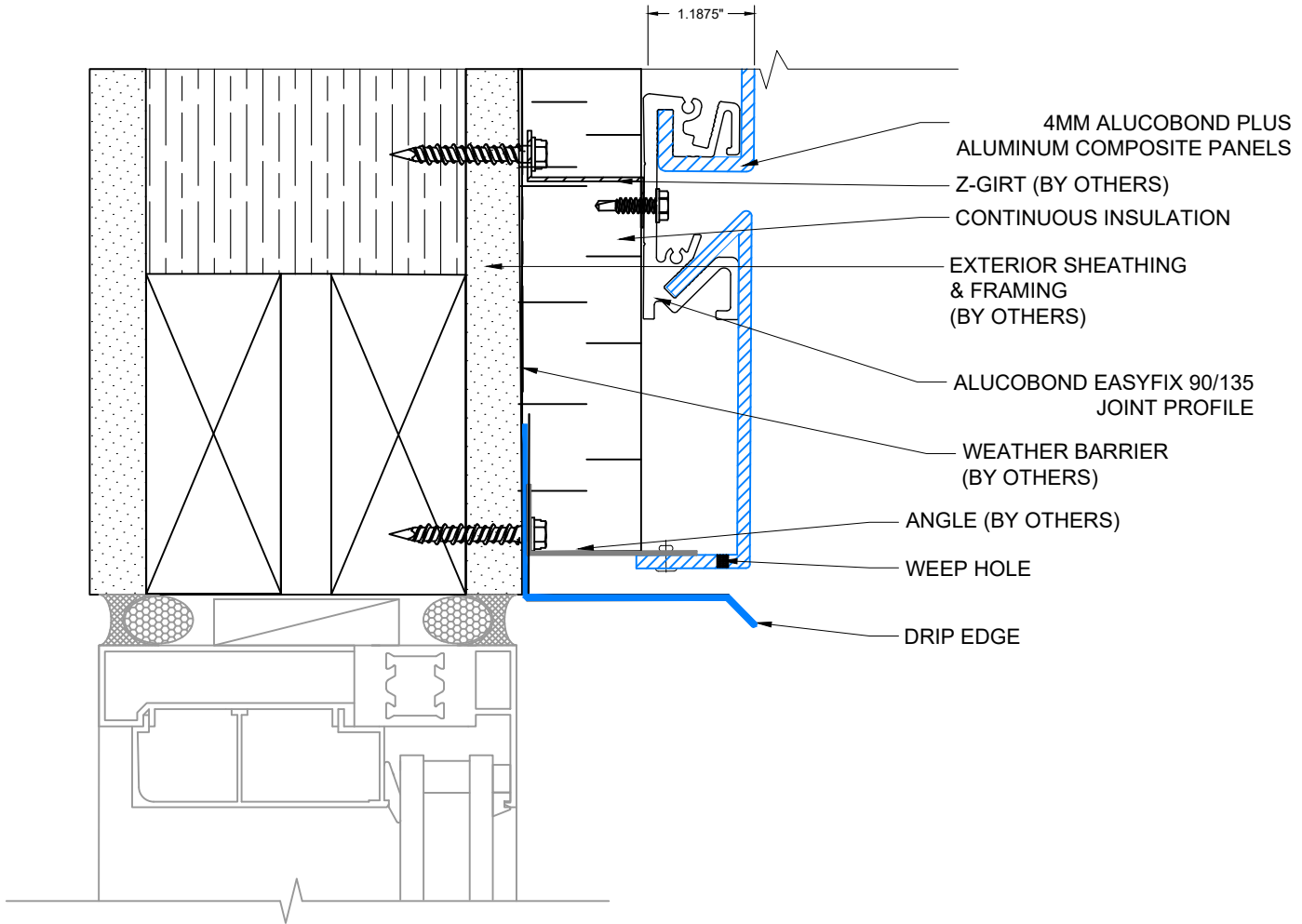

5a

WINDOW HEAD



ALUCOBOND® EasyFix™: Horizontal - Exterior Insulation

Disclaimer Note: 3A COMPOSITES USA, INC. DOES NOT MAKE ANY WARRANTIES, EXPRESS OR IMPLIED INCLUDING MERCHANTABILITY AND FITNESS FOR PURPOSE. THIS INFORMATION IS GIVEN TO THE BEST OF OUR KNOWLEDGE BUT WITHOUT ANY OBLIGATION ON OUR PART. PATENTED PENDING

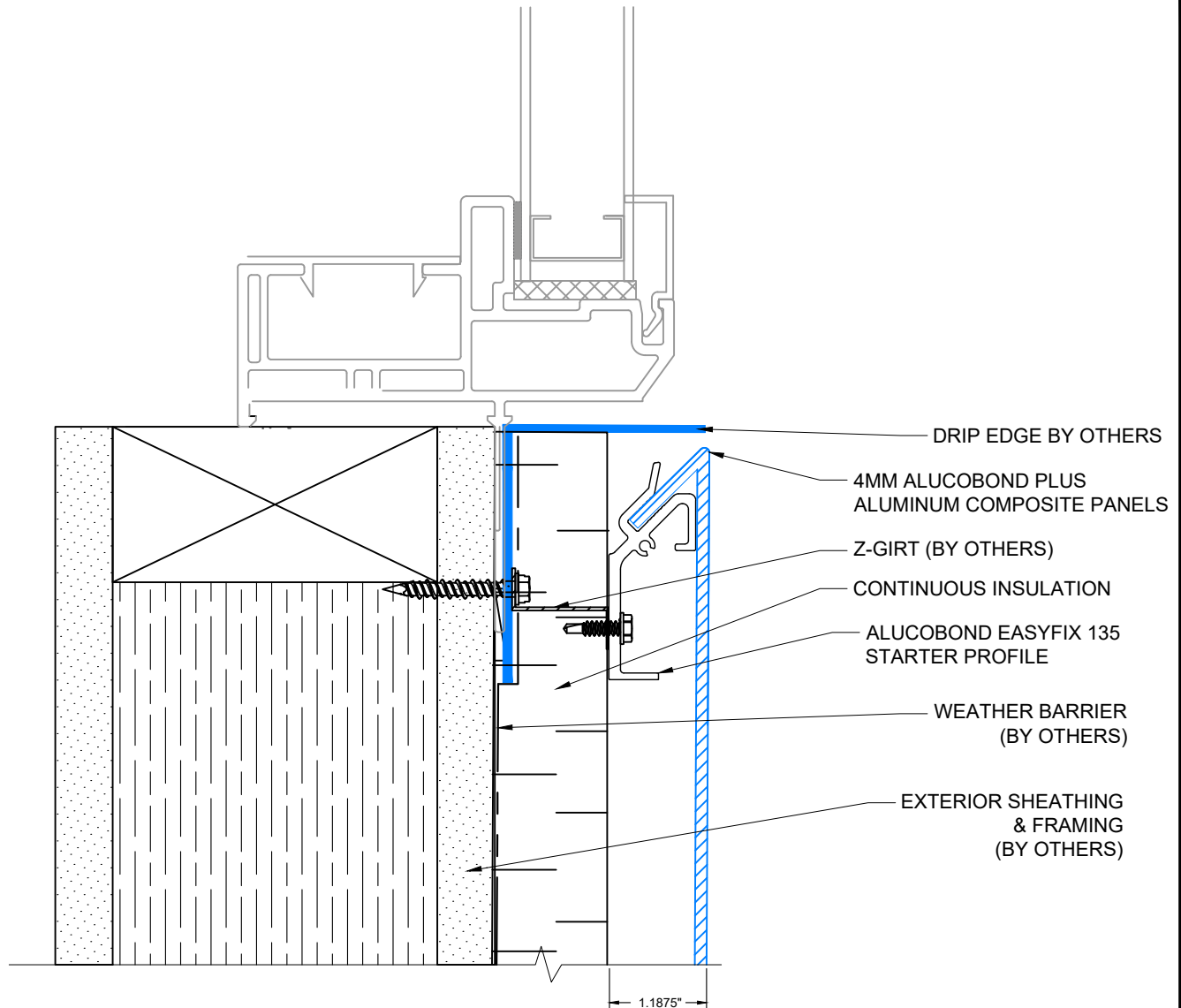

View Point-
Side View

6 WINDOW SILL DETAIL

3A COMPOSITES | **ALUCOBOND® PLUS**
GIVING SHAPE TO GREAT IDEAS

ALUCOBOND[®] EasyFix[™]: Horizontal - Exterior Insulation

Disclaimer Note: 3A COMPOSITES USA, INC. DOES NOT MAKE ANY WARRANTIES, EXPRESS OR IMPLIED INCLUDING MERCHANTABILITY AND FITNESS FOR PURPOSE. THIS INFORMATION IS GIVEN TO THE BEST OF OUR KNOWLEDGE BUT WITHOUT ANY OBLIGATION ON OUR PART. PATENTED PENDING

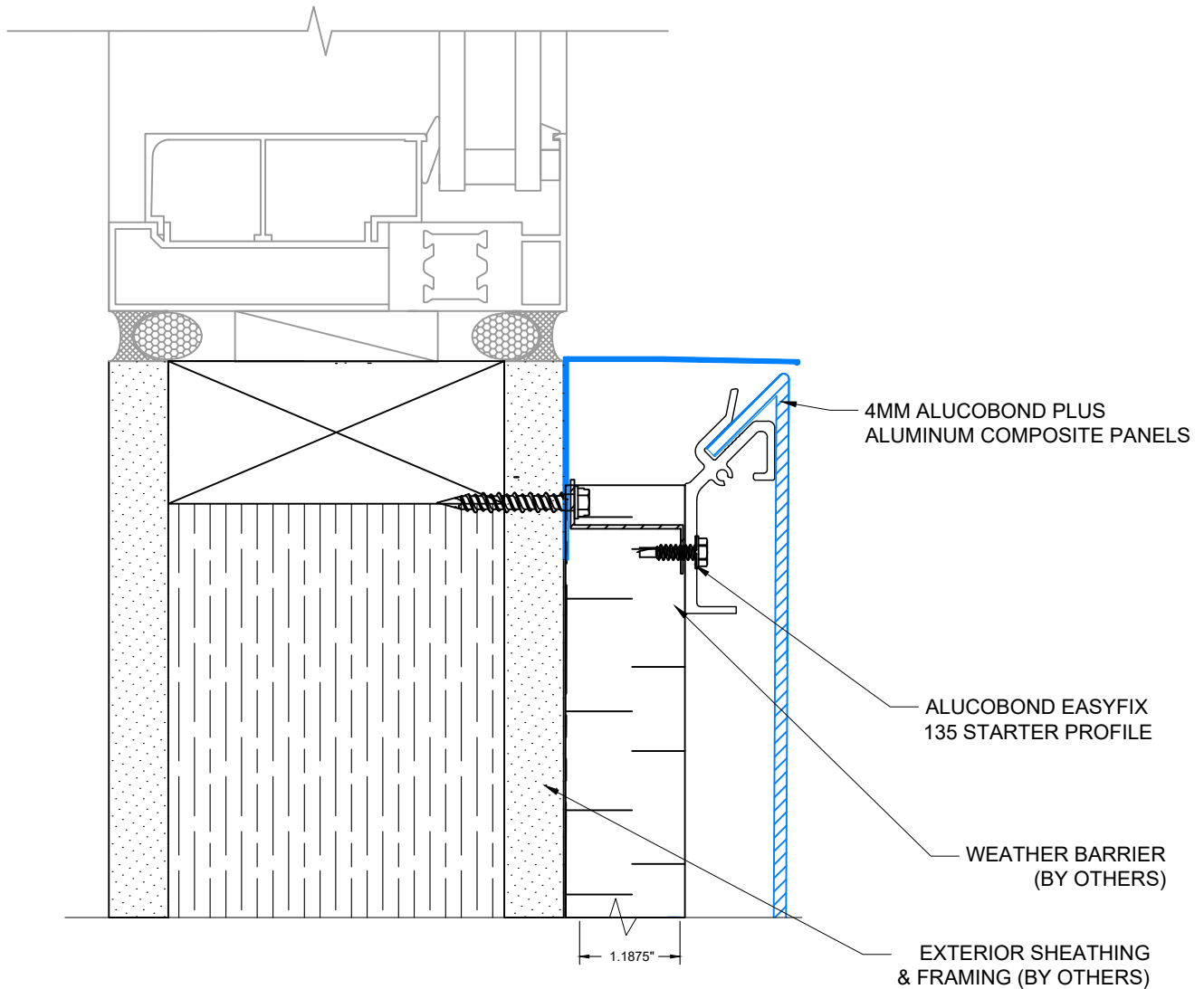

View Point-
Side View

6a WINDOW SILL OPTIONAL



ALUCOBOND® EasyFix™: Horizontal - Exterior Insulation

Disclaimer Note: 3A COMPOSITES USA, INC. DOES NOT MAKE ANY WARRANTIES, EXPRESS OR IMPLIED INCLUDING MERCHANTABILITY AND FITNESS FOR PURPOSE. THIS INFORMATION IS GIVEN TO THE BEST OF OUR KNOWLEDGE BUT WITHOUT ANY OBLIGATION ON OUR PART. PATENTED PENDING

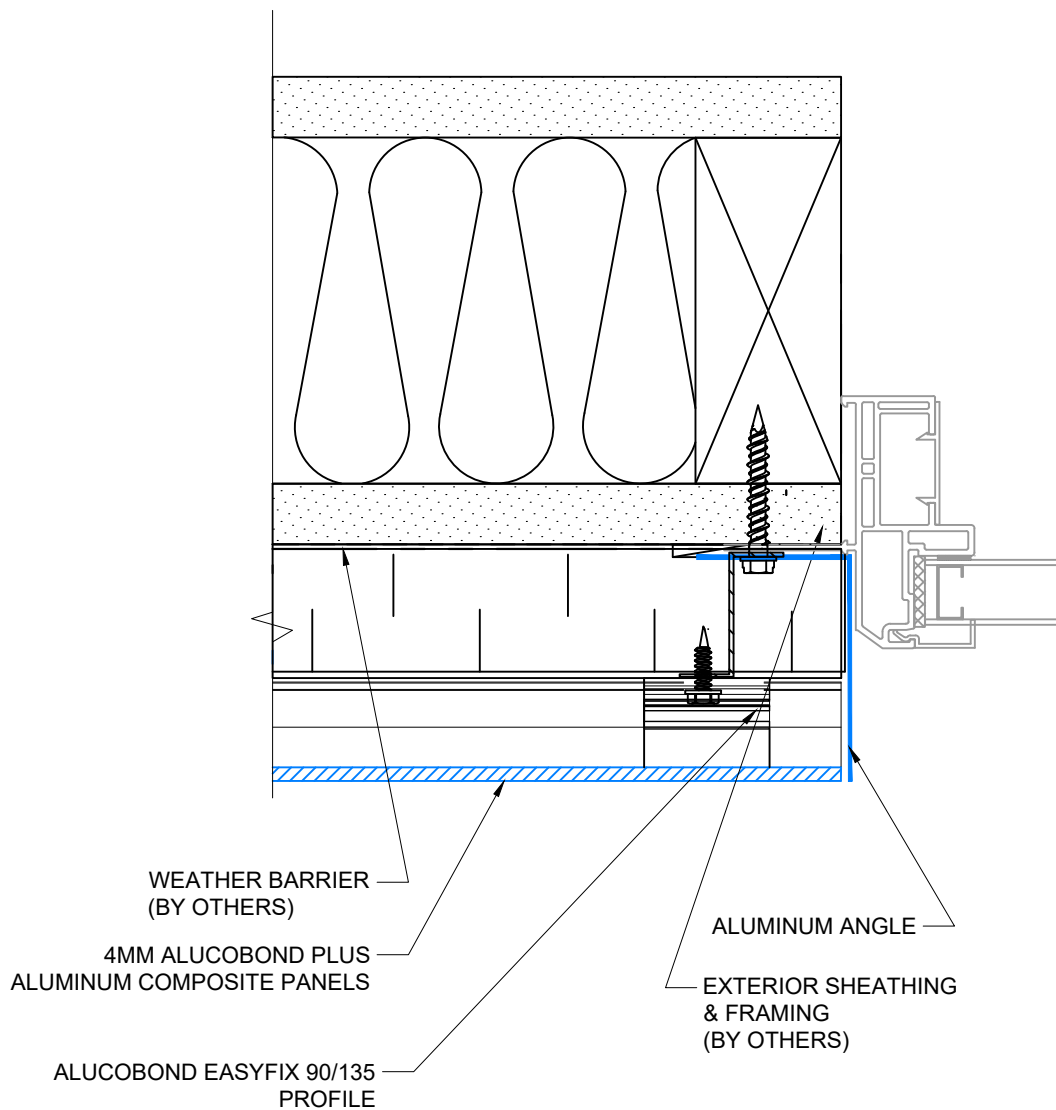

View Point-
Top View

7 WINDOW JAMB DETAIL



ALUCOBOND® EasyFix™: Horizontal - Exterior Insulation

Disclaimer Note: 3A COMPOSITES USA, INC. DOES NOT MAKE ANY WARRANTIES, EXPRESS OR IMPLIED INCLUDING MERCHANTABILITY AND FITNESS FOR PURPOSE. THIS INFORMATION IS GIVEN TO THE BEST OF OUR KNOWLEDGE BUT WITHOUT ANY OBLIGATION ON OUR PART. PATENTED PENDING

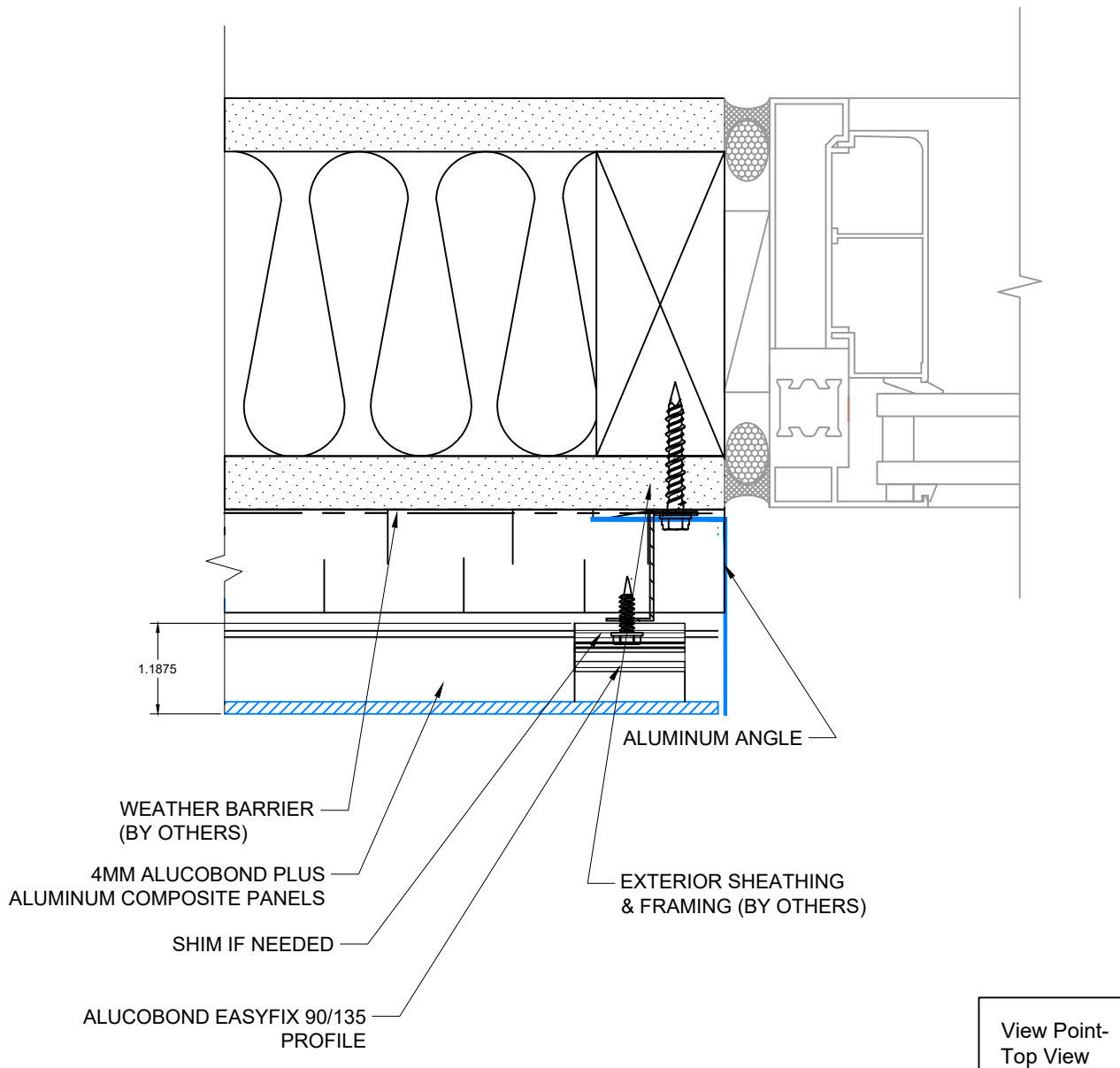

7a WINDOW JAMB OPTIONAL



ALUCOBOND® EasyFix™: Horizontal - Exterior Insulation

Disclaimer Note: 3A COMPOSITES USA, INC. DOES NOT MAKE ANY WARRANTIES, EXPRESS OR IMPLIED INCLUDING MERCHANTABILITY AND FITNESS FOR PURPOSE. THIS INFORMATION IS GIVEN TO THE BEST OF OUR KNOWLEDGE BUT WITHOUT ANY OBLIGATION ON OUR PART. PATENTED PENDING

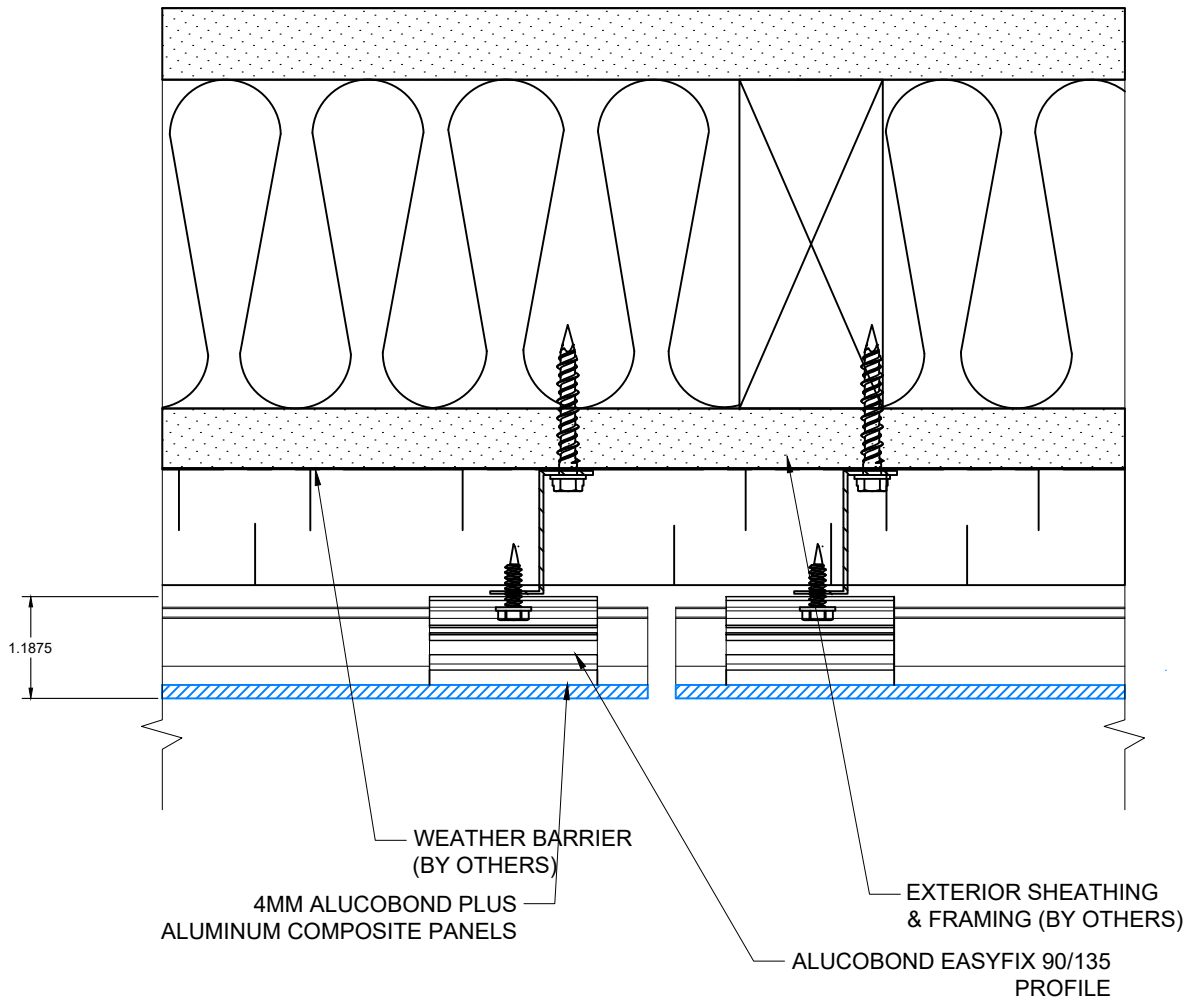

View Point-
Top View

8

VERTICAL JOINT DETAIL



ALUCOBOND® PLUS

GIVING SHAPE TO GREAT IDEAS

ALUCOBOND® EasyFix™: Horizontal - Exterior Insulation

Disclaimer Note: 3A COMPOSITES USA, INC. DOES NOT MAKE ANY WARRANTIES, EXPRESS OR IMPLIED INCLUDING MERCHANTABILITY AND FITNESS FOR PURPOSE. THIS INFORMATION IS GIVEN TO THE BEST OF OUR KNOWLEDGE BUT WITHOUT ANY OBLIGATION ON OUR PART.
 PATENTED - PENDING

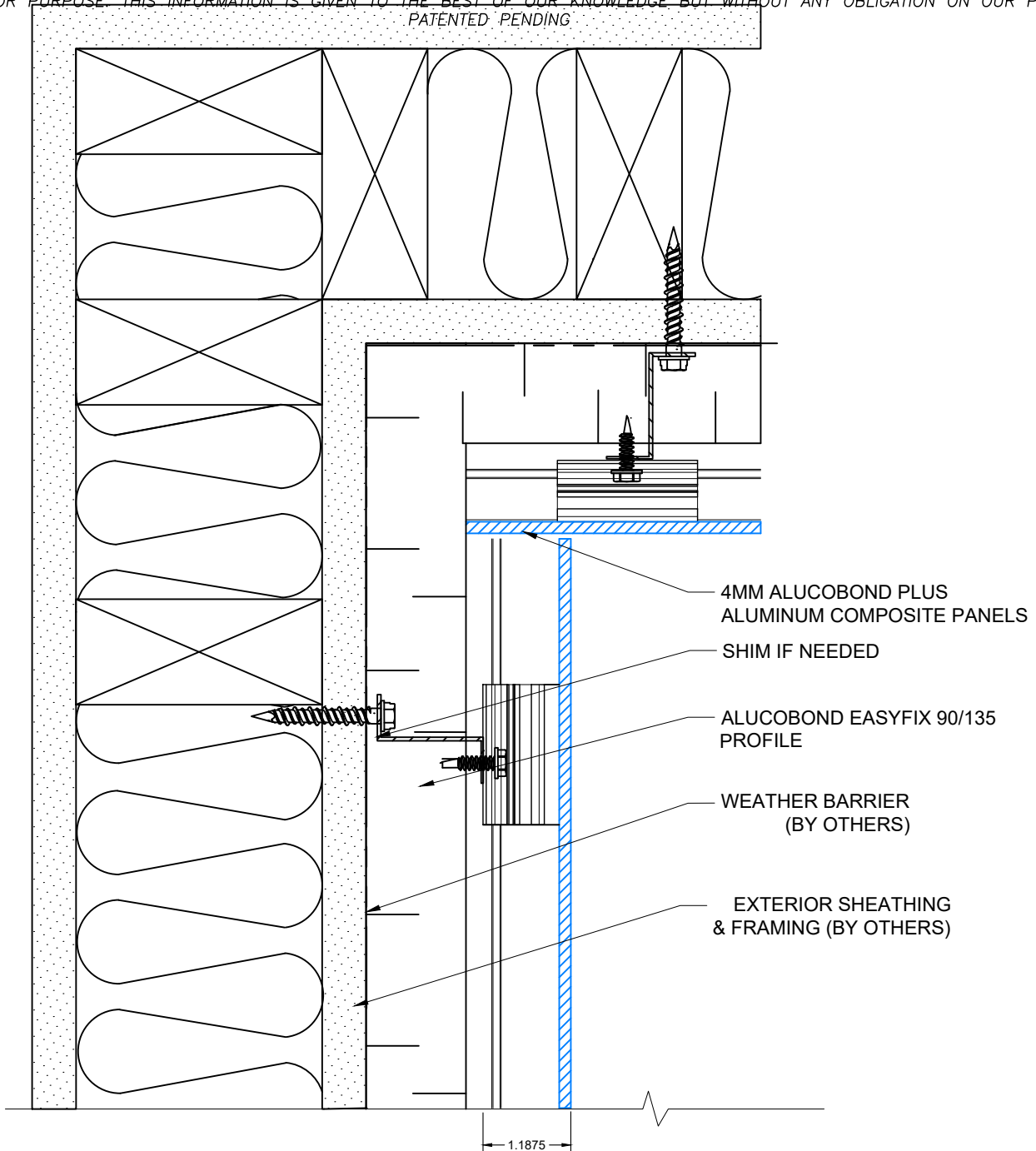

View Point-
Top View

9

INSIDE CORNER DETAIL



ALUCOBOND® PLUS
 GIVING SHAPE TO GREAT IDEAS